

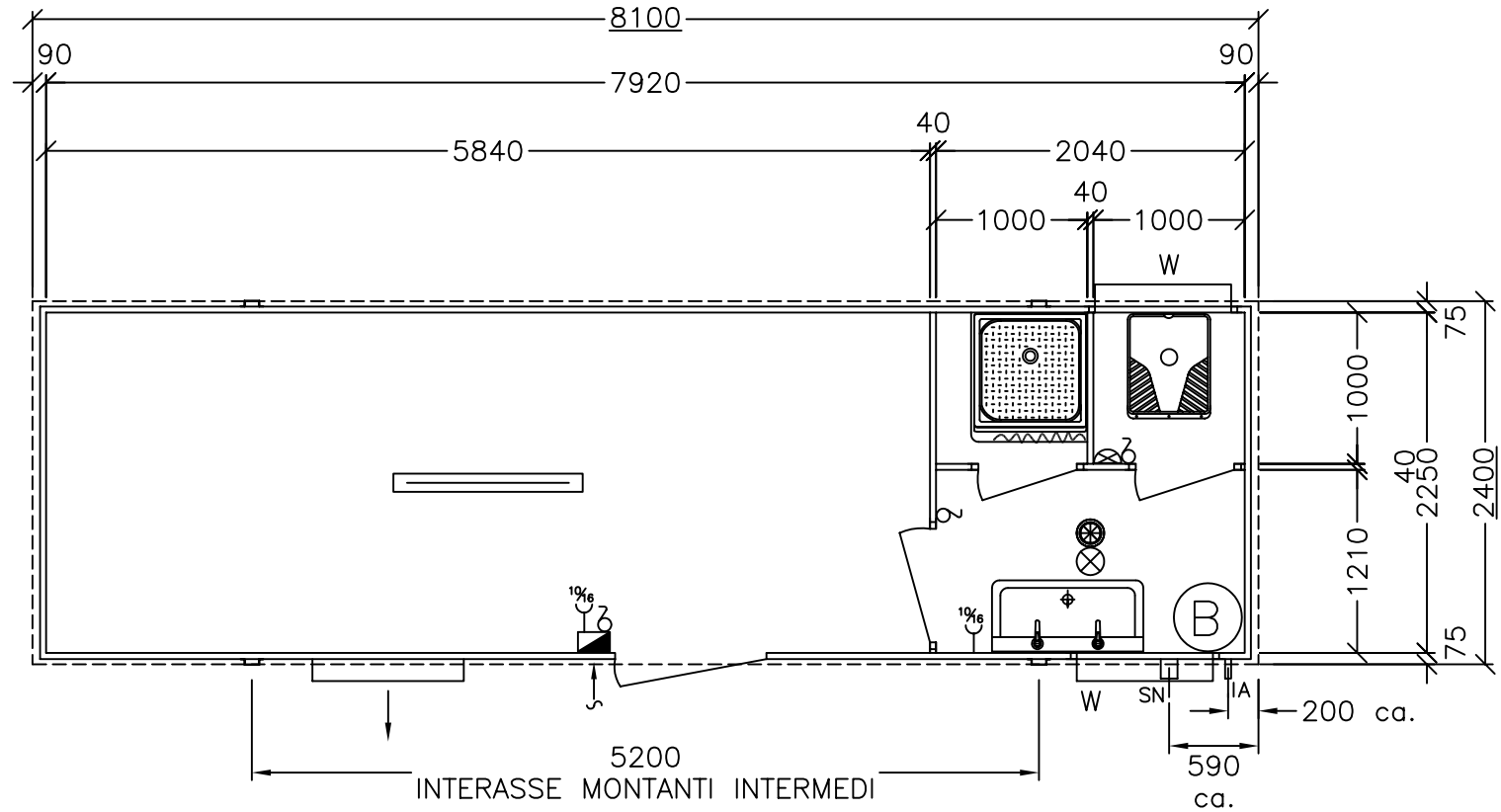







PLANIMETRIA GENERALE PREFABBRICATO

H.INT. mt. 2,70



4855 / 2



LEGENDA SIMBOLI

-  INGRESSO CORRENTE CON SCATOLA DI DERIVAZIONE
-  INTERRUTTORE SEMPLICE
-  PRESA BIVALENTE 10/16 A.
-  PLAFONIERA A SOFFITTO 60 W.
-  PLAFONIERA A PARETE 60 W.
-  PLAFONIERA A TUBO FLUORESCENTE 1 x 58 W.
-  QUADRO ELETTRICO GENERALE CON SALVAVITA
-  BOILER ELETTRICO DA 100 LT.

ADDUZIONI E SCARICHI

- PRESSIONE MASSIMA DI INGRESSO
ADDUZIONE ACQUA 3 ATM.
-  IA || ADDUZIONE ACQUA \varnothing 1/2 POLLICE
-  SNI || SCARICO ACQUE NERE \varnothing 110 MM.
-  PILETTA DI SCARICO A PAVIMENTO